

# SENOFEE

ITEM NO: HVS116T



## Current Type Single-axis Inclinometer

Email: [info@senofee.com](mailto:info@senofee.com) / <http://www.senofee.com>

## General Description

HVS116T is an analog current output sensor. The customer can calculate the inclination of the current product through the analog current output. This product uses high-precision MEMS micro-electromechanical imported technology, and internally uses temperature compensation and correction. Anti-electromagnetic interference performance. The quantity range is optional. The product is simple to use and easy to install. It is a solar energy, wind energy engineering machinery and equipment, automation equipment, etc. The best choice for industry control (products can be customized)

## Specifications

|  |                   |   |
|--|-------------------|---|
| Accuracy: 0.01°                                      | Resolution: 0.01° | Protection rating: IP67                 |
| Measuring axis: Y-axis                               |                   | Measuring range: ±90°                   |
| Power supply voltage range: 9-35v                    |                   | Output signal: 4-20mA , 0~20mA          |
| Anti-vibration performance: >2000g                   |                   | Wide temperature working: -40°C ~ +85°C |
| Store temperature : -55°C~+100°C                     |                   |   |
| Zero temperature drift (-40 ° C ~ 85 ° C): ± 0.005 ° |                   |   |

## Applications

- |                                      |                                      |
|--------------------------------------|--------------------------------------|
| 1: Industrial automatic leveling     | 2: Medical equipment                 |
| 3: Solar automatic tracking          | 4: Tower tilt monitoring             |
| 5: Lifting angle control of cranes   | 6: Structural deformation monitoring |
| 7: Measuring and mapping instruments | 8: Military equipment automation     |



## Electrical parameters

| Parameters          | conditions | Min | Standard | Max  | Unit |
|---------------------|------------|-----|----------|------|------|
| power supply        |            | 5   | 12 24    | 36   | V    |
| Working current     |            | 15  | 30       | 40   | mA   |
| Working temperature |            | -40 |          | +85  | °C   |
| Store temperature   |            | -55 |          | +100 | °C   |

## Technical Data

| Parameters                           | conditions                             | HVS116T-10 | HVS116T-30 | HVS116T-60 | HVS116T-90 |
|--------------------------------------|--|------------|------------|------------|------------|
| Measuring rang                       |  | ±10°       | ±30°       | ±60°       | ±90°       |
| Measuring axis                       |  | Y          | Y          | Y          | Y          |
| Resolution                           |  | 0.01°      | 0.01°      | 0.01°      | 0.01°      |
| Zero temperature coefficient         | -40°C~85°C                             | 0.005°/°C  | 0.005°/°C  | 0.005°/°C  | 0.005°/°C  |
| Absolute accuracy                    |  | 0.01°      | 0.015°     | 0.02 °     | 0.03°      |
| Zero Position                        | 0° Output                              | 2.5V       | 2.5V       | 2.5V       | 2.5V       |
| Power on time                        |  | <3S        | <3S        | <3S        | <3S        |
| Output frequency                     | 5-100HZ                                | Optional   | Optional   | Optional   | Optional   |
| Baud rate                            | 2400-115200                            | Optional   | Optional   | Optional   | Optional   |
| Shockproof                           | 2000g.0.5ms、3Times/Axis(half sinusoid) |            |            |            |            |
| Average no reason Obstacle time MTBF | ≥800000hours/times                     |            |            |            |            |
| Insulation resistance                | ≥100MΩ                                 |            |            |            |            |
| Output signal                        | 4-20mA ,0~20mA                         |            |            |            |            |
| Weight                               | 100g(without cable)                    |            |            |            |            |

This Technical data only list ± 10 ° , ± 30 ° , ± 60 ° , ± 90 ° series for reference, other measuring range please refer to the adjacent parameters.

## Key words

**Resolution :** Refers to the sensor in measuring range to detect and identify the smallest changed value.

**Absolute accuracy :** Refers to in the normal temperature circumstances, the sensor absolute linearity, repeatability, hysteresis, zero deviation, and transverse error comprehensive error.

**Response time :** Refers to the sensor in an angle change, the sensor output value reached the standard time required.

## Mechanical Parameters

|                    |                              |
|--------------------|------------------------------|
| Connectors         | 1.2m lead cable ( standard ) |
| Protection glass   | IP67                         |
| Enclosure material | Aluminum Oxide               |
| Installation       | 4*M4 screws                  |

## Ordering information

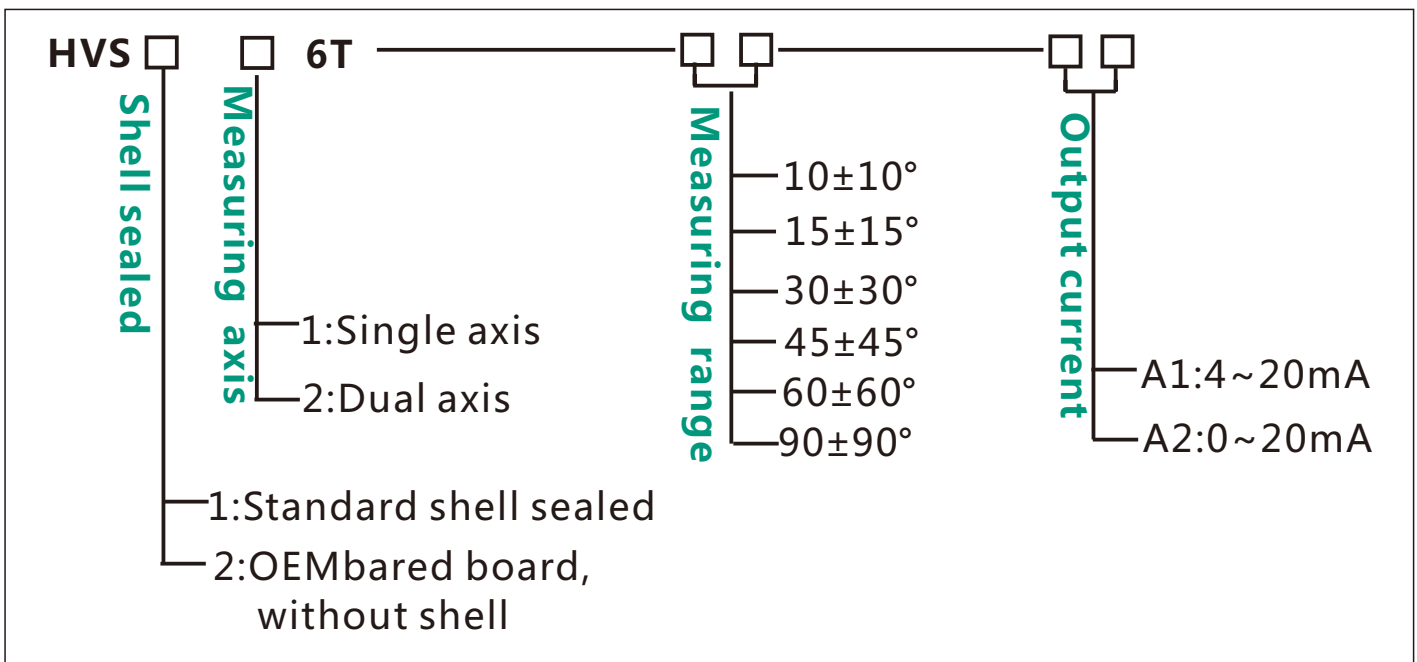

E.g : HVS **11** 6 T -**10**-**A1** : standard/single axis/±10° Measuring range /4mA-20mA output current

## Electrical Connection

|            |          |                    |        |
|------------|----------|--------------------|--------|
| Line color | RED      | BLACK              | GREEN  |
| function   | DC 9~36V | GND Power Negative | Y axis |

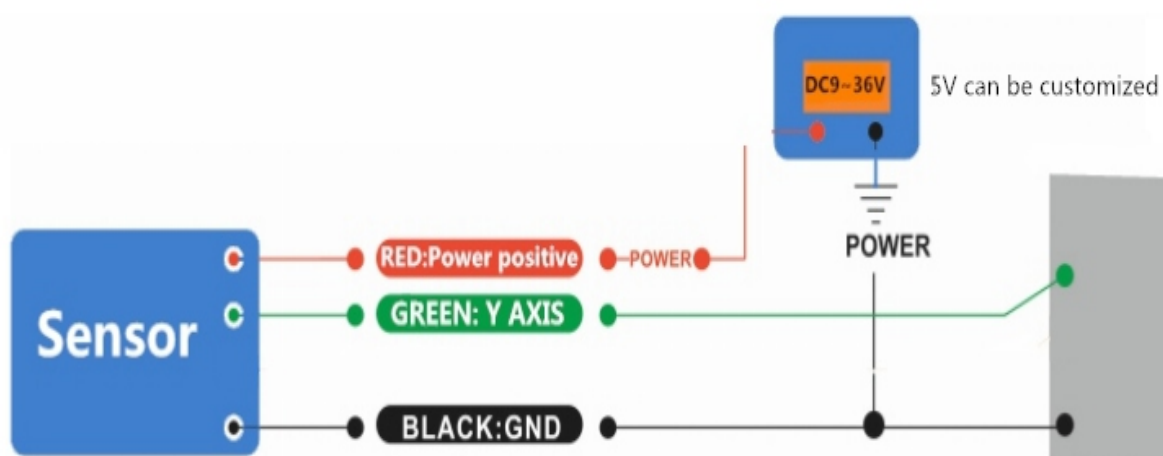

## Working Principle

Adopt the European import of core control unit, using the capacitive micro pendulum principle and the earth gravity principle, when the the inclination unit is tilted, the Earth's gravity on the corresponding pendulum will produce a component of gravity, corresponding to the electric capacity will change, by enlarge the amount of electric capacity , filtering and after conversion then get the inclination.

## Product size chart

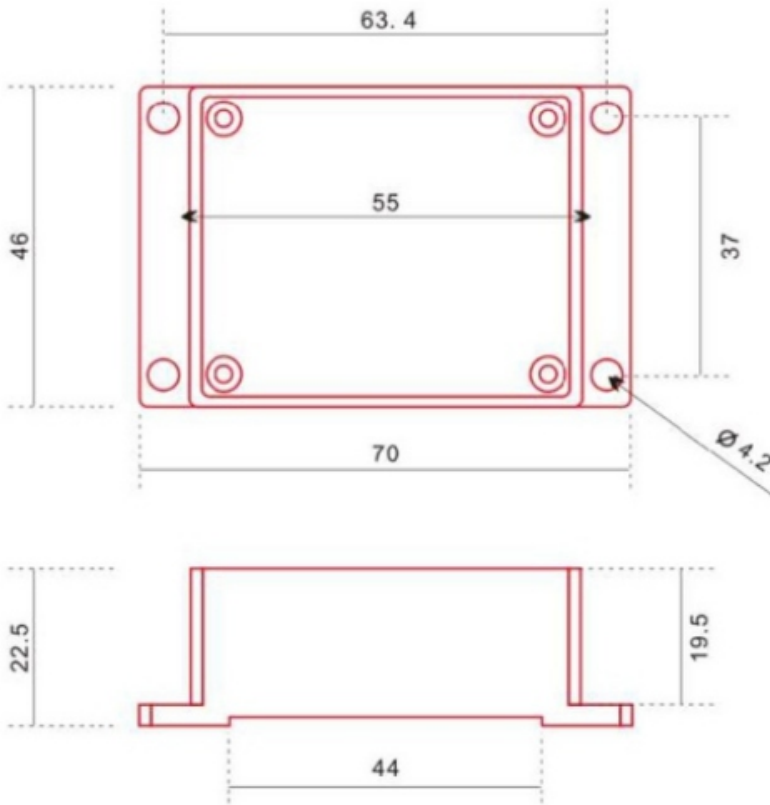

## Measuring direction

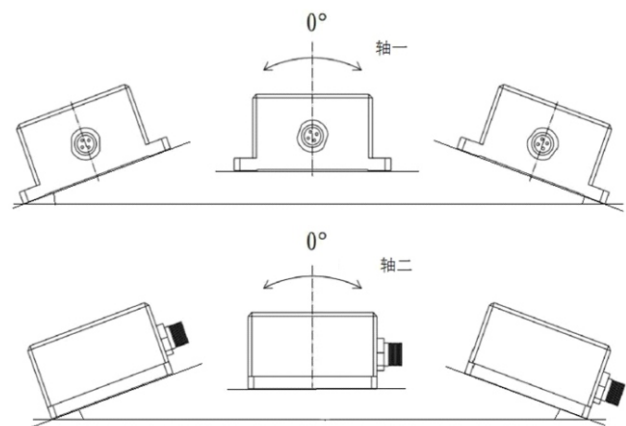
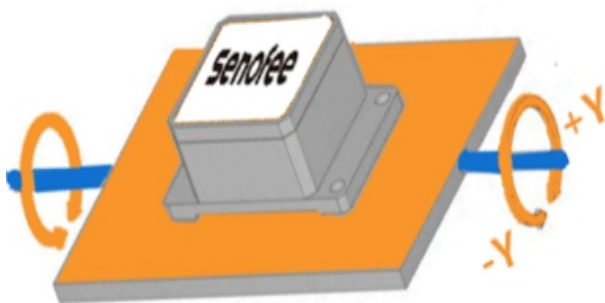

## Production installation notes:

Please follow the correct way to install tilt sensor, incorrect installation can cause measurement errors, with particular attention to the "surface", "line": :

- 1 ) The Sensor mounting surface and the measured surface must be fixed closely, smoothly, stability, if mounting surface uneven likely to cause the sensor to measure the angle error. See Figure Pic.AB
- 2) The sensor axis and the measured axis must be parallel ,the two axes do not produce the angle as much as possible. See Figure Pic.CD :

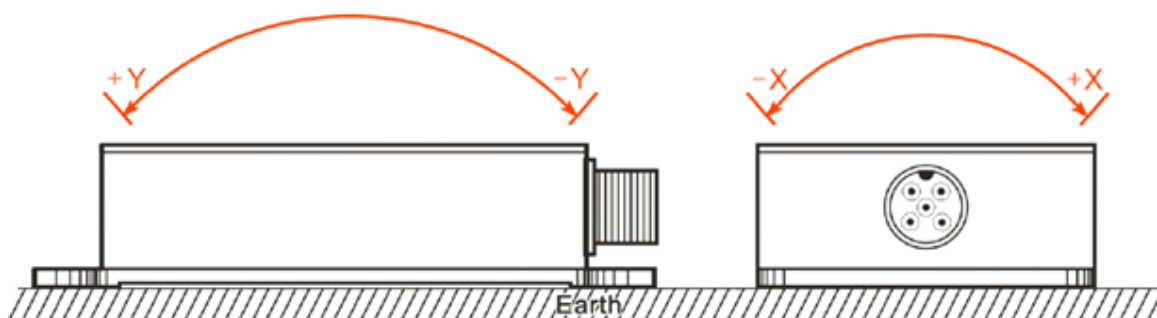

The axis of the sensor must be parallel to the axis to be measured, and the two axes should not be angled as much as possible.

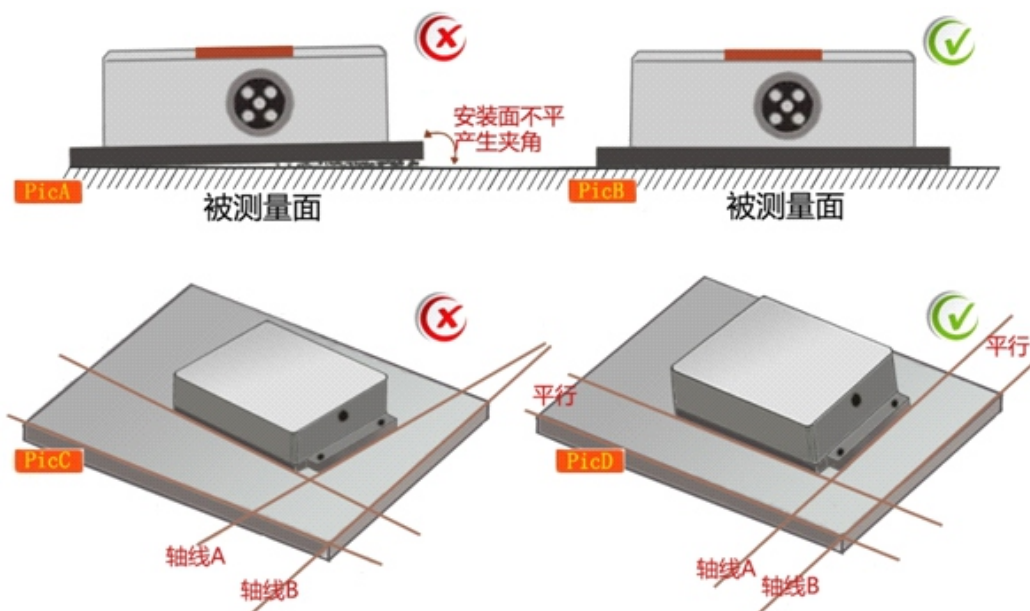

The mounting surface of the sensor must be tight, flat and stable when it is fixed to the surface to be measured.

# SENOFEE

ITEM NO: HVS116T

## **Current Type Single-axis Inclinometer**

Email: [info@senofee.com](mailto:info@senofee.com) / <http://www.senofee.com>